



Broadband 300 - 500 MHz Front-End System for GMRT

Internal Technical Report

3 February, 2011

Giant Metrewave Radio Telescope

Khodad

By

Aarti Kulkarni, Manisha Parate & V.B. Bhalerao

Front-End Lab

**National Centre for Radio Astrophysics, Pune
Tata Institute of Fundamental Research.**



Abstract

The purpose of this project is to improve the bandwidth of the 327 MHz Front End Systems of GMRT. Presently, the system bandwidth is 40 MHz, limited by the Low Noise Amplifier (LNA) & Band pass filters (BPF) . The existing 327 MHz Kildal feed (Dipole plus reflector plus Beam forming Ring) has been modified for broader frequency coverage as far as the impedance matching is concerned by about 200 MHz. One unit of 327 MHz Front-end box was modified with low loss Sage Laboratories make QUADRATURE HYBRID (Polarizer) , wideband Low Noise MMIC Amplifier & broadband filter to give 300 MHz - 500 MHz overall broadband bandpass response with good sensitivity. The modified system was mounted on C-08 Antenna, Source ON/OFF deflection tests were carried out. Sensitivity G/T_{sys} measurement tests also have been carried out. The results for all the individual units & also for integrated system are presented in this report. G/T_{sys} plot also has been presented.

Acknowledgement

We are thankful to our Group Coordinator **Mr. A. PraveenKumar**, who identified this Hittite LNA MMIC & assigned us this task. We are also thankful for his guidance, constant encouragement, supervision, motivation & help in the preparation of this report.

We would like to express my sincere gratitude to **Prof. Jayaram Chengalur**, *Dean, NCRA* for his inspiration & motivation.

We are also greatly indebted to **Prof. Yashwant Gupta**, *Dean, GMRT* & **Prof. S. K. Ghosh**, *Center Director, GMRT* for their encouragement.

We gratefully acknowledge the support & suggestions from **Mr. Anil Raut**. We are especially grateful to our colleagues **Hanumant Rao, Vishal Temkar, Digambar Jangade, Santosh Bhor, S. Ramesh, K T Thorat & Barkund** who helped in different ways to complete this work.

We are also thankful to Workshop for fabrication & assembly help.

We take this opportunity to thank all our GMRT staff that has directly or indirectly helped in our work.

Index

| SR. NO. | CONTENTS | Page NO. |
|---------|--------------------------------------|----------|
| 1. | Overview of GMRT Receiver System | 1 |
| 2. | Low Noise Amplifier | 3 |
| 3. | Wideband Band - Pass Filter | 8 |
| 4. | QUADRATURE HYBRID | 11 |
| 5. | Broadband 327 MHz Front-End Response | 14 |
| 6. | Deflection on CYGA at C08 Antenna | 16 |
| 7. | References | 18 |

| SR. NO. | Figures & plots | Page NO. |
|---------|---|----------|
| 1. | Photograph of Hittite Low Noise Amplifier Unit | 4 |
| 2. | Schematic of Hittite 2-stage amplifier | 6 |
| 3. | Layout of Hittite 2-stage amplifier (a) Top Layer Layout (b) Bottom Layer Layout | 6 |
| 4. | Gain, Return Loss & Noise temperature of Hittite LNA | 7 |
| 5. | Photograph of Band pass filter unit | 8 |
| 6. | Responses of Band Pass Filter | 8 |
| 7. | Schematic of Wideband Band Pass Filter (a) 7 th order 300 MHz High pass filter (b) 7 th order 500 MHz Low Pass Filter | 9 10 |
| 8. | photograph of TEMLINE series QH from Sage Lab | 11 |
| 9. | QUADRATURE HYBRID measurements | 12 |
| 10. | Photograph of Integrated Front-End unit | 14 |
| 11. | Modified FE unit Test Measurements at LAB | 15 |
| 12. | Sensitivity test on C08 Antenna | 16 |
| 13. | Deflection Measurements on CYGA at Antenna Base | 17 |

Annexure

| | | |
|----|---|----|
| A. | Hittite HMC616 LP3 MMIC LNA datasheet | 19 |
| B. | TEMLINE QUADRATURE HYBRID from Sage Lab | 29 |

Table

| | | |
|----|--|---|
| 1. | Comparative table of Noise temperature for different Noise sources | 5 |
|----|--|---|

1. Overview of GMRT Receiver System

Giant Meter-wave Radio Telescope (GMRT) currently operates at five observing bands centered at 150 MHz, 235 MHz, 327 MHz, 610 MHz and an L-band extending from 1000 to 1450 MHz. The L-band is split into four sub bands centered at 1060MHz, 1170 MHz, 1280 MHz and 1390 MHz, each with a bandwidth of 120 MHz. The L-band receiver also has a bypass mode in which the entire RF band can be brought down to the Antenna Base Receiver (ABR).

The 150 MHz, 235 MHz, 327 MHz bands of GMRT have 40 MHz bandwidth and 610 MHz band has about 60 MHz of bandwidth. Lower frequency bands from 150 to 610 MHz have dual circular polarization which is named as CH1 and CH2 for right hand circular polarization and left hand circular polarization respectively. The higher frequency L-band has dual linear polarization (Vertical and Horizontal polarization) named CH1 and CH2 respectively. At the lower frequencies the polarizer placed before the Low Noise Amplifier (LNA) converts the received linear polarization to circular. At L-band, in order to keep the system temperature low, this element is not inserted into the signal path, and the linear polarized signals are fed directly to the LNA. To calibrate the gain of the receiver chain, it is possible to inject an additional noise signal (of known strength) into the input of the LNA. It is possible to inject noise at any one of four levels. These are called Low cal, Medium cal, High cal and Extra high cal and are of monotonically increasing strength.

To minimize crosstalk between different signals a phase switching facility using separate Walsh functions for each signal path is available at the RF section of the receiver.

At the Common Box the signals go through one additional stage of amplification. The common box has a broad band amplifier which covers the entire frequency range of the GMRT (10 - 1800 MHz). The band selector in the common box can be configured to take signals from any one of the six RF Front Ends. The common box (and the entire receiver system) has the flexibility to be configured for receiving either both polarizations at a single frequency band or a single polarization at each of two different frequency bands. It is also possible to swap the polarization channels whenever required. For observing strong radio sources like Sun, solar attenuators of 14 dB, 30 dB or 44 dB are available in

the common box. In addition there is a power monitor whose output can be continuously monitored to verify the health of the subsystems upstream of the common box.

The first synthesized local oscillator converts the RF band to an IF band centered at 70 MHz. The synthesized local oscillator has a frequency range of 100 MHz to 1795 MHz. The frequency range 100 MHz to 600 MHz is covered by synthesizer-1 and 605 MHz to 1795 MHz is covered by synthesizer-2. The local oscillator frequency from 100 MHz to 354 MHz can be set with a step size of 1 MHz and the frequency range from 355 MHz to 1795 MHz can be set with a step size of 5 MHz. At the IF stage, bandwidth of 5.5 MHz, 16 MHz or a full available RF bandwidth can be selected. The IF at 70 MHz is then translated to a second IF at 130 MHz and 175 MHz for CH1 and CH2 respectively.

The maximum bandwidth available at this stage is 32 MHz for each polarization channel this frequency translation is done so that they can be transported to Central Electronics Building (CEB) over a single fiber optic cable. An Automatic Level Control (ALC) facility is provided at the output stage of IF which can be bypassed whenever required.

The IF signal at 130 MHz and 175 MHz along with telemetry and LO round trip phase carriers directly modulate a laser diode operating at 1300 nm wavelength which is coupled to a single mode fiber-optic link between the receiving antennas and the CEB.

2.Low Noise Amplifier

Broadband 300-500 MHz LNA

LNA is designed using Hittite Microwave Corporation make HMC616LP3 GaAs SMT pHEMT MMIC Low Noise Amplifier. The features of this device are:

Frequency Range: 175 MHz - 660 MHz.

Low Noise Figure: 0.5 dB

High Gain: 24 dB

High output IP3: 37 dBm

Single supply: +3V to +5V

16 Lead 3 mm * 3 mm QFN package.

The performance of E-pHEMT technology offers many well-suited characteristics, including:

1. Saturated drain-source current (I_{dss}) of less than 10 μ A at room temperature.
2. Drain current (I_d) of approximately 0 at a gate-source voltage (V_{gs}) of 0.
3. Superior output power (P_{out}) and high efficiency with bias voltages of less than +3 VDC.
4. No thermal runaway effects (common to bipolar transistors).
5. No secondary breakdown mechanism.
6. The ability to survive under high mismatch conditions.

However, E-pHEMT technology can also provide a combination of high gain, low noise, and wide dynamic range in high-linearity LNA applications. These types of applications have been made practical with the availability of low-cost plastic-packaged surface-mount E-pHEMT devices specifically designed for LNA applications.

We designed a 300 MHz - 500 MHz two stage amplifier with HMC616LP3 device in two stages. Previously we tried with this device as first stage & MAR 6 as a second device.

Though it is in 2nd stage it affects noise temperature by 4-5 deg k.

So we used same device as a 1st & 2nd amplifier in 2-stage amplifier.

Noise figure of the cascaded amplifiers can be calculated by Friis formula

$$NF = NF_1 + \frac{NF_2 - 1}{G_1} + \dots + \frac{NF_K - 1}{G_1 G_2 \dots G_K}$$

Where NF = Noise Figure

NF1 , NF 2 .. = Noise figures of respecting stages in the system.

G1 , G2 .. GK= Gain of respected stages in the system.

Gk= Gain of respected stages in the system.

This design is based on Application circuit given in their datasheet. We optimized the circuit, by tuning the gate & drain inductors for our required frequency range.

Schematic is shown in fig 2. Layout for top & bottom layer are shown in fig.3(a) & 3(b) respectively.

One of the units is shown in fig. 1

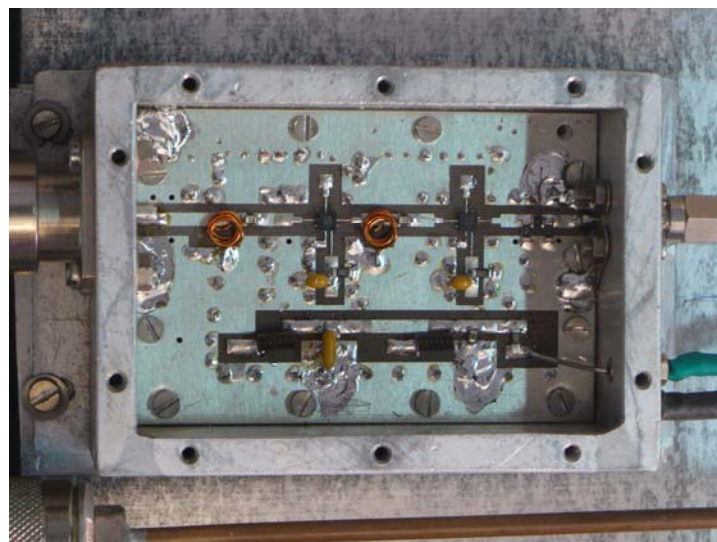

Fig. 1 Hittite 300-500 MHz Wideband LNA

Specifications:

Freq Range: 300 MHz - 500 MHz

Device Used: HMC616LP3 Hittite Microwave Corporation.

GaAs SMT pHEMT MMIC Low Noise Amplifier.

Substrate material: ROGERS Corporation make ULTRALAM 2000, 0.8 mm thickness.

Return Loss: Better than 11 dB over the frequency range of interest.

Gain: at 300 MHz -- 34.3 dB

500 MHz -- 26.3 dB

Noise Temp: Avg. 58 deg K (with Agilent Noise Source 346A (old))

35 deg K (with Noisecomm Noise Source NC346 A(new))

NoiseComm Noise Source NC346A is recently purchased & calibration is valid at present.

The comparative table of Noise temperature measured with Agilent & Noisecomm Noise sources is shown in table 1.

| Frequency (MHz) | Agilent 346 A | Noisecomm NC346A |
|-----------------|---------------|------------------|
| 300 | 55.6 | 36.7 |
| 327 | 56.0 | 36.0 |
| 400 | 57.8 | 35.7 |
| 500 | 57.8 | 34.5 |

Table 1. Comparative table of Noise temperature for different Noise sources

Measured plots for Gain , RL & Noise temp. are shown in fig. 4

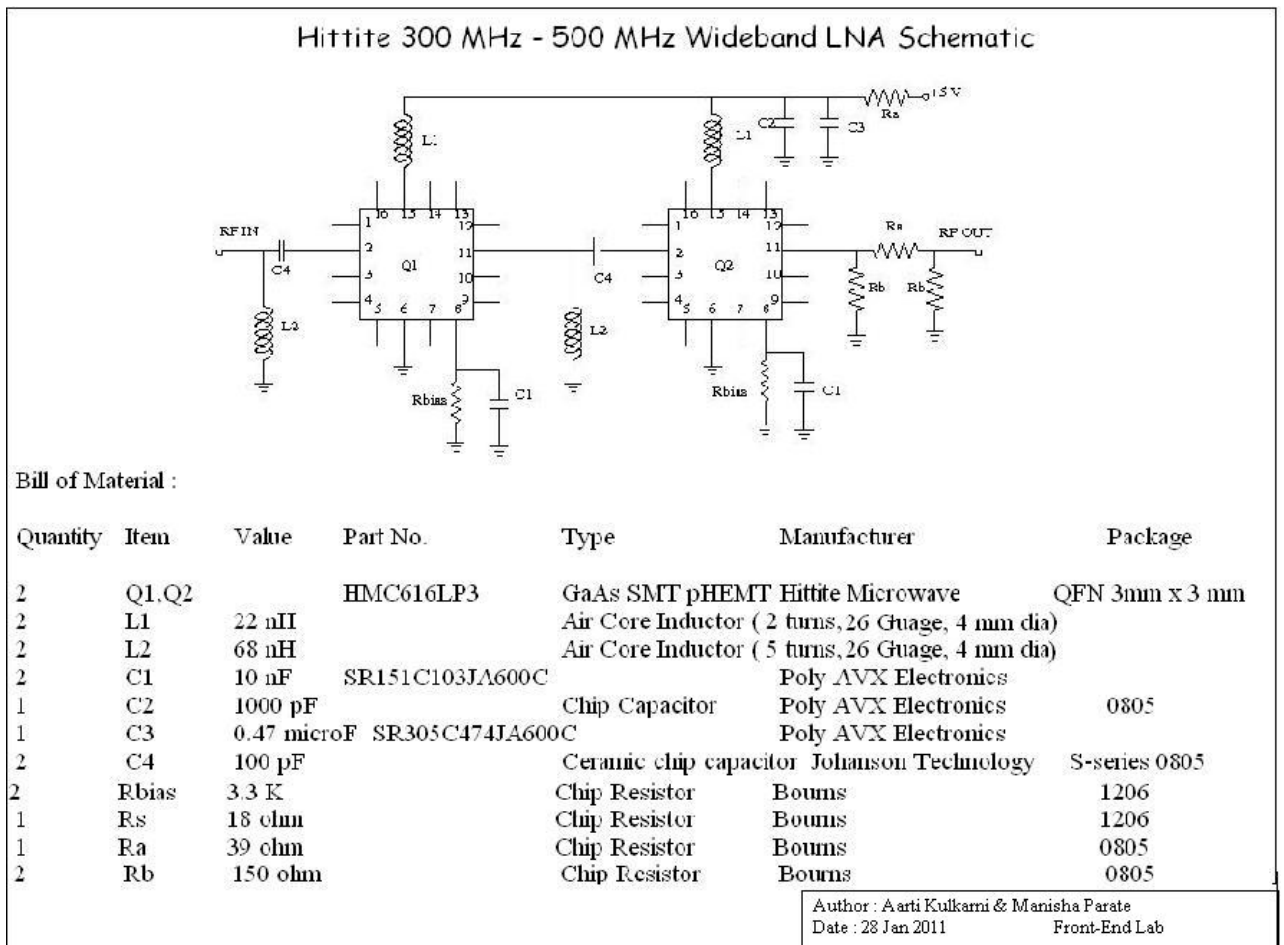

Fig.2 Schematic of Hittite 2-stage Amplifier

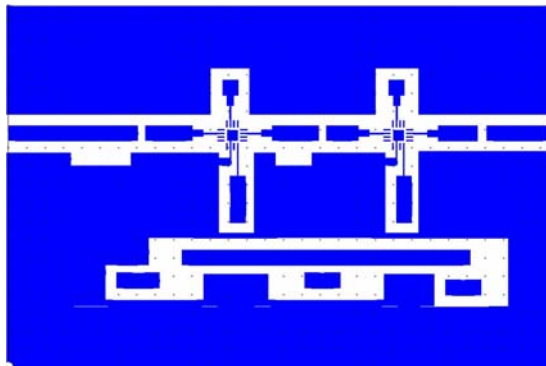
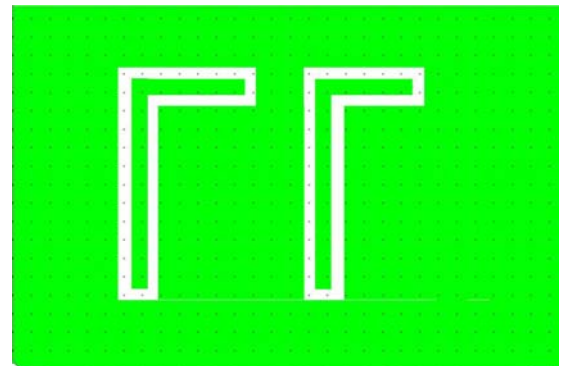

Fig.3(a) Top Layer Layout



(b) Bottom Layer Layout

Fig.4 300-500 MHz Hittite LNA

H4: Gain & Return Loss

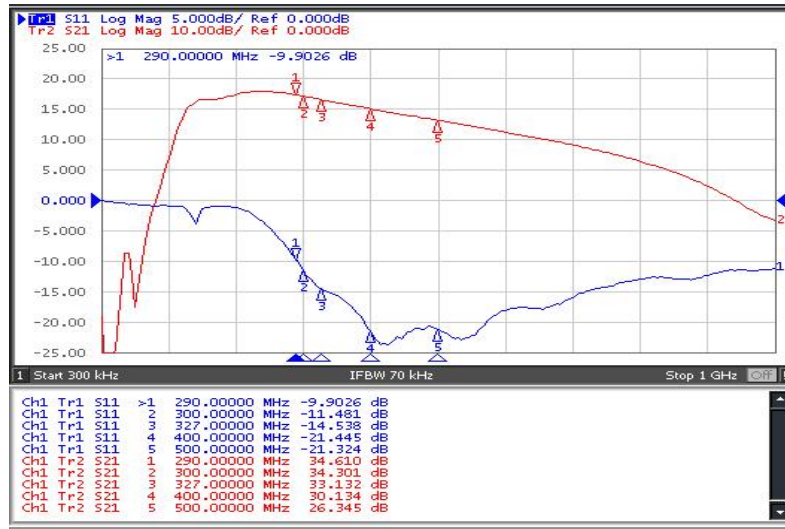

H5: Gain & Return Loss



H4: Gain & Noise Temperature

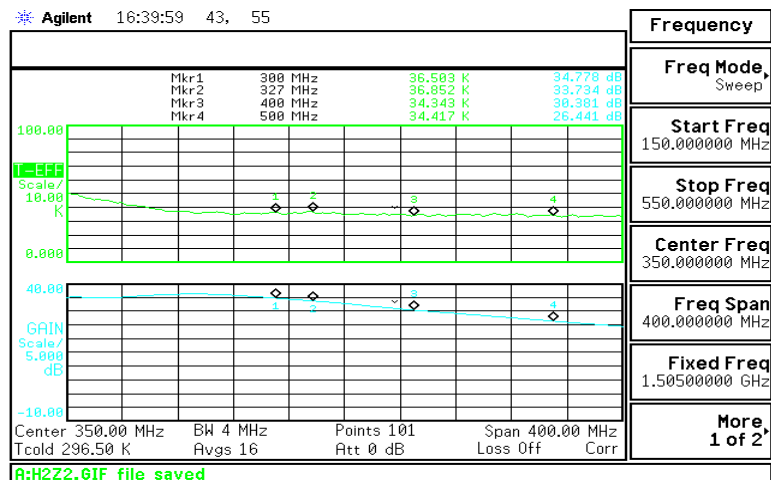

H5: Gain & Noise Temperature

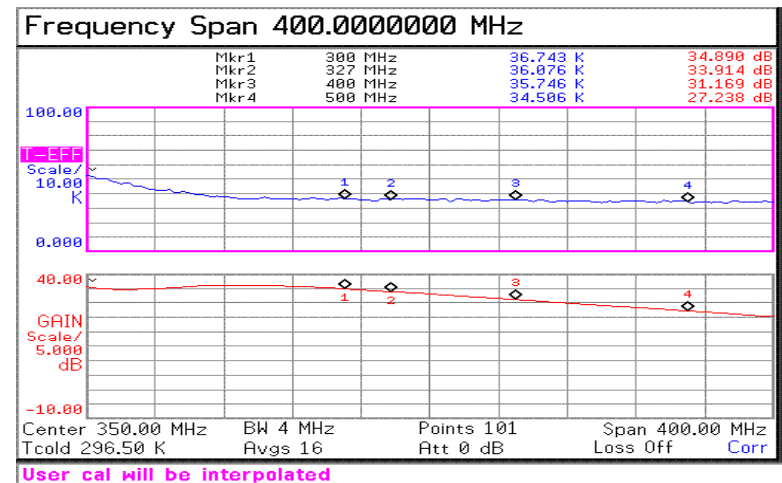

300-500 MHz Band Pass Filter

The Band Pass Filter covering a frequency range of 300 - 500 MHz was implemented by a combination of 7th order elliptic High pass & Low pass filters. This is designed by Mr. V B Bhalerao, uses L & C components

Fig. 5 shows measured responses of BPF.

Fig. 6 shows a picture of Wideband Band pass filter.

Fig 7 (a) shows the schematic of the high pass filter & Fig 7 (b) shows the schematic of the high pass filter.

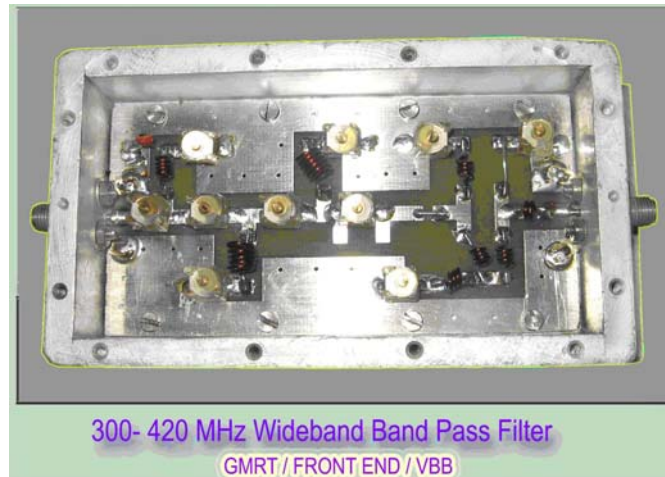

Courtesy Mr. Bhalerao

Fig. 5 Wideband Band Pass Filter

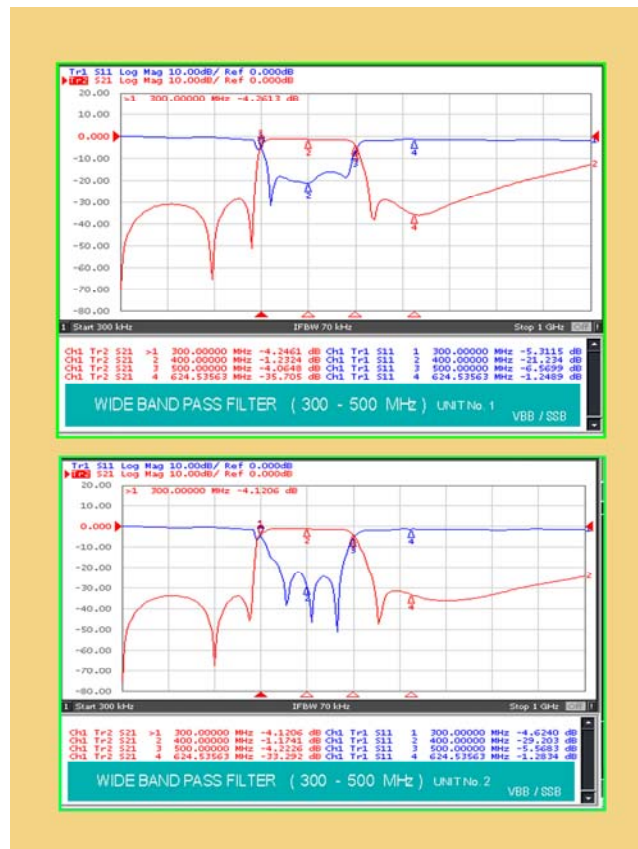

Courtesy Mr. Bhalerao

Fig. 6 Responses of Band Pass Filters

Fig 7 (a)

Schematic diagram of 7 th order Elliptic type 300 MHz High Pass filter

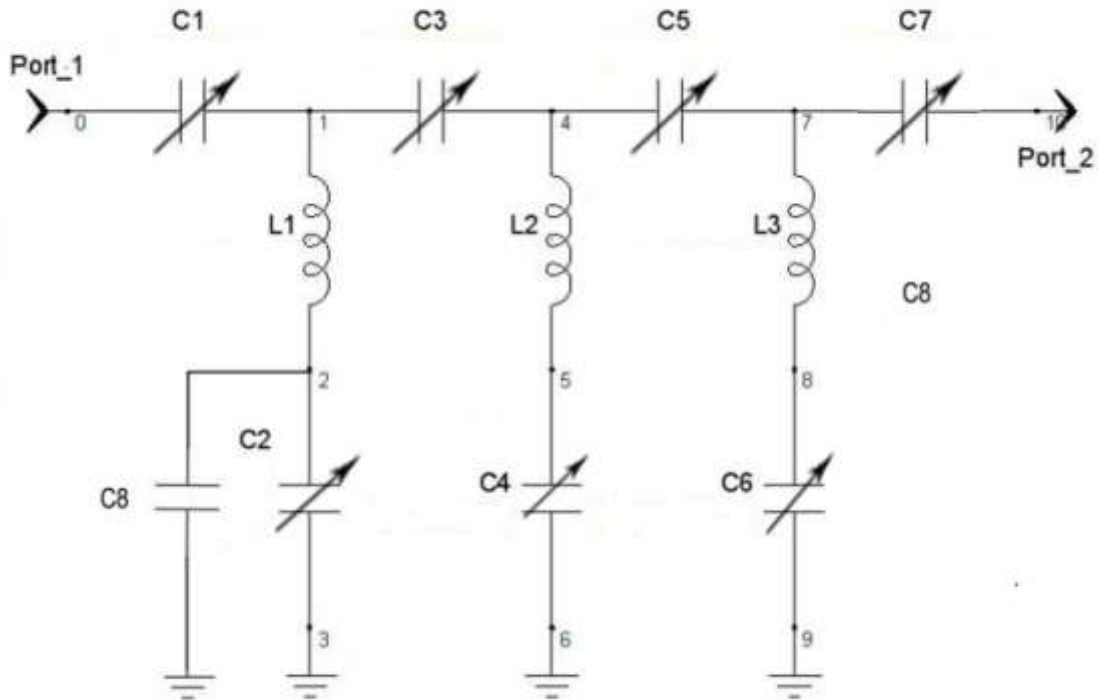

PART LIST :

L1 : 4 T , ID 3 mm , # 22

L2 : 5 T , ID 5 mm , # 22

L3 : 5 T , ID 5 mm , # 22

C8 : 15 pF

C1,C2,C3 , C4 , C5 , C6 ,C7 : 2 - 18 pF Trimmer Capacitors

(BC Components 2222 809 05 Series- PTFE Film)

Fig 7 (b)

Schematic diagram of 7th order Elliptic type 500 MHz Low Pass Filter

VBB / 20.12.2010

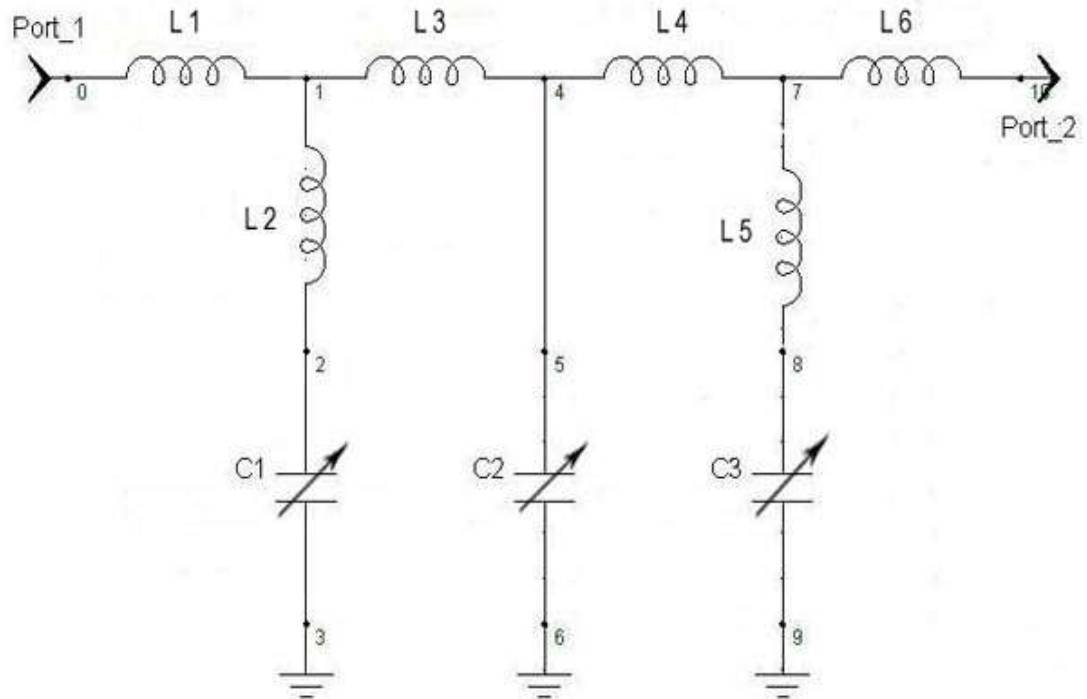

PART LIST :

L1 , L2 , L5 , L6 : 2T , ID 3 mm , # 22

L3 , L4 : 3 T , ID 3 mm , # 22

C1 , C2 , C3 : 2 - 18 pF Trimmer Capacitors

(BC Components 2222 809 05 Series- PTFE Film)

4. QUADRATURE HYBRID

The linearly polarized signals received by the orthogonally placed dipoles are fed to the low loss QUADRATURE HYBRID manufactured by Sage Laboratories.

They are TEMLINE series QUADRATURE HYBRID, octave band. All four ports are connectorised with N-Type female connectors. This hybrid acts as a polarizer & converts the linearly polarized signals to two orthogonal circular polarizations (RHCP & LHCP)

The speciality of this polarizer it's very low insertion loss of less than 0.1 dB.

Fig. 8 shows the picture of the Polarizer.

All the measurements are taken for Insertion loss, return loss & isolation are shown in fig. 9

FEATURES:

- Type "N" Connectors.
- Average Power Rating 1000 watts , Normalized at 1 GHz
- 1 dB maximum Unbalance.
- Frequency Range: 250 MHz - 500 MHz.
- Isolation, min (dB) : 20
- VSWR (Max) : 1.20
- Insertion Loss (max): 0.1
- Model Number 750
- Phase QUADRATURE error, max ($^{\circ}$) : ± 1



TEMLINE™ SERIES

Courtesy: Sage Lab

Fig. 8 TEMLINE QUADRATURE HYBRID

Fig. 9 Sage Lab QUADRATURE HYBRID 250_500 MHz

Return Loss S11



Return Loss S44

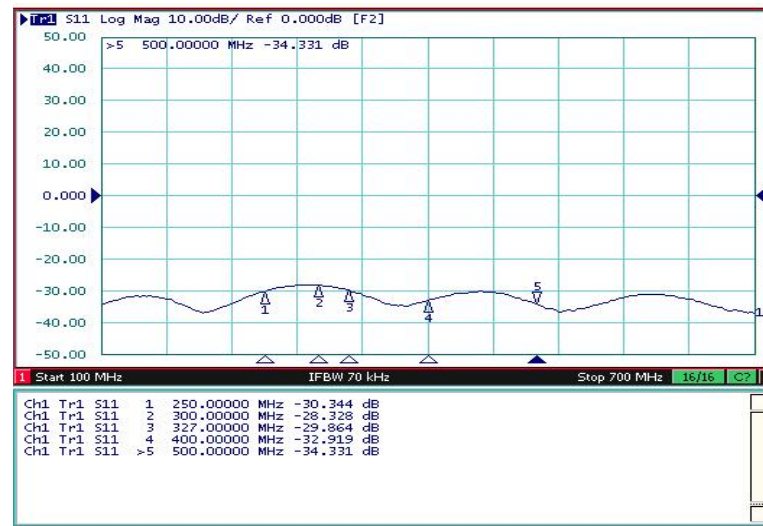

Insertion Loss S21 : Phase & Magnitude



Insertion Loss S34 Phase & Magnitude



continued

S31 Phase & Magnitude



S24 Phase & Magnitude



Isolation S41

5. Broadband 300-500 MHz Front-End Response

Wideband Sage Laboratories make TEMLINE Quadrature Hybrid (Polarizer), Hittite Low Noise Amplifier & lumped element filter are integrated with post amplifier & phase switch and RF ON/OFF switch to give overall wideband 300 MHz- 500 MHz FE system.

Integrated 300 - 500 MHz Front-End system is shown in fig. 10

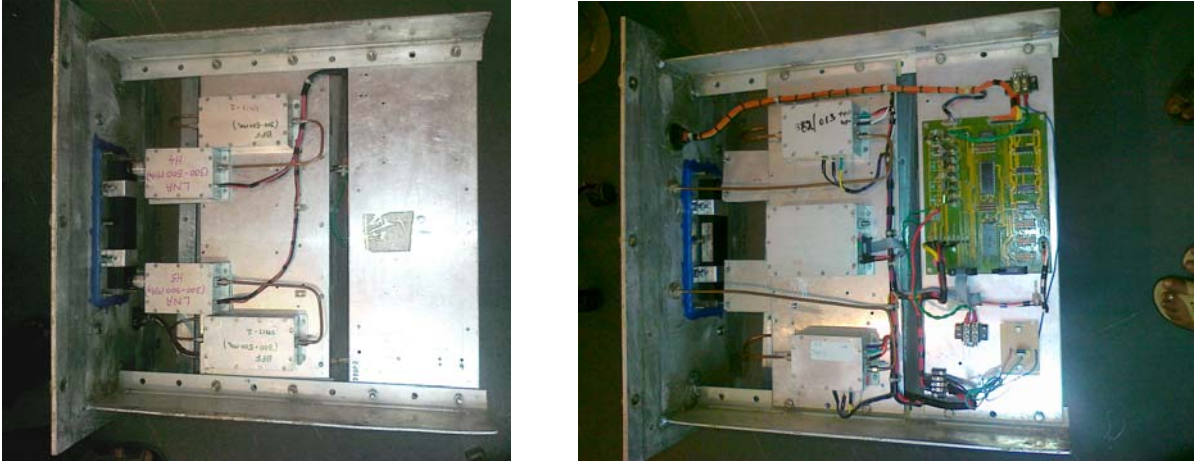
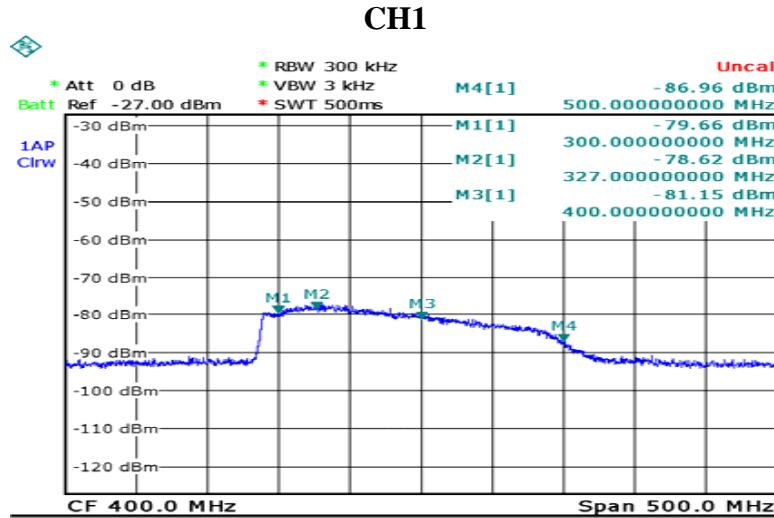

Fig. 10 Integrated 300 - 500 MHz Front-End system

Modified individual Front-End Box Response as well as FE & Common Box combined response at lab for both channels are shown in fig 11.

Fig. 11 300 _ 500 MHz Modified FE Box No. 129



Date: 6.JAN.2011 12:46:20

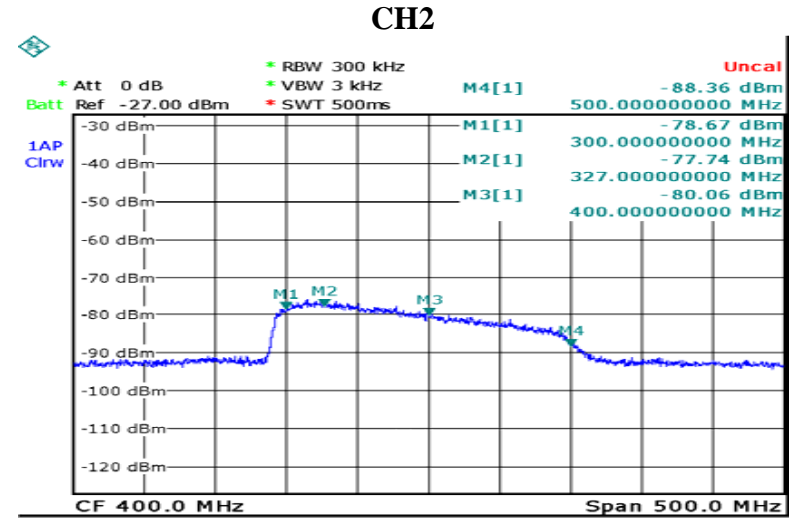

Date: 6.JAN.2011 12:43:20

300 _ 500 MHz Modified FE Box No.129 with Common Box No. 118

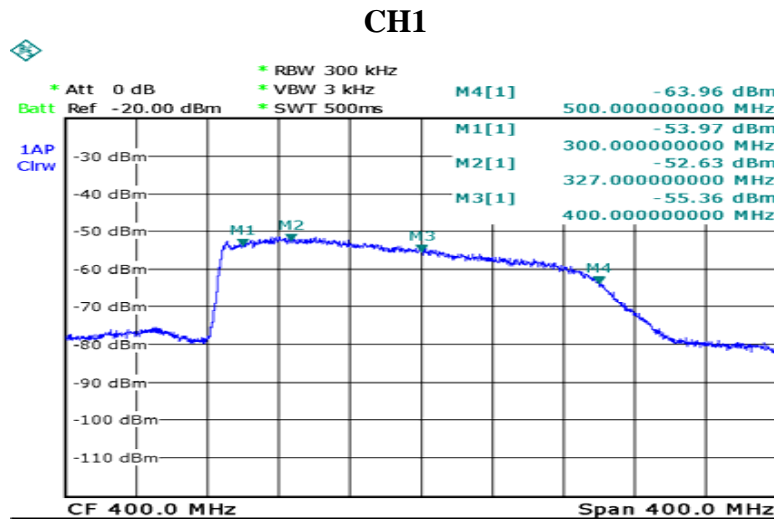

Date: 6.JAN.2011 14:50:11

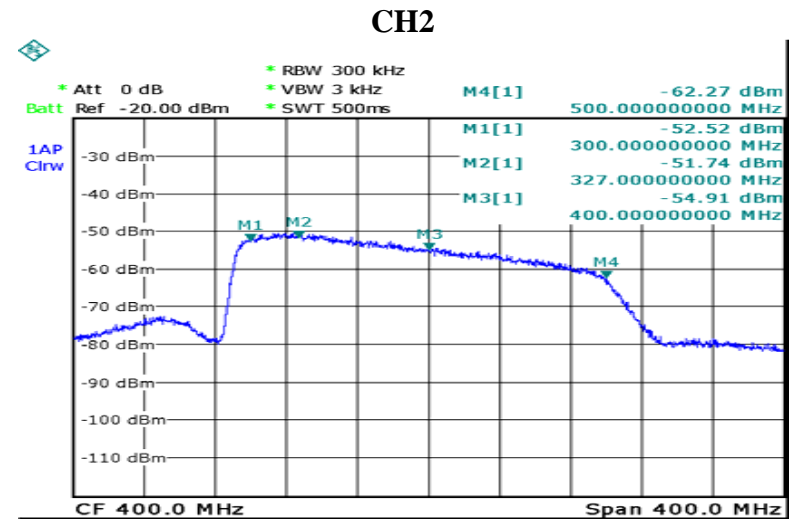

Date: 6.JAN.2011 14:55:08

6.Deflection on CASA at C8 Antenna

The modified 300-500 MHz FE Box is mounted on C08 Antenna and the deflection test was done on standard astronomical calibrator source CYGA on 12th Jan 2011.

Deflection measurements are shown in fig 13.

Afterwards sensitivity was measured by Prof. Jayram Chengalu on C08 Antenna.

The plot shows G/Tsys for the existing GMRT 327 MHz system (red), recently installed & measured 300 - 400 MHz system (green) and 300-500 MHz system (pink points) using standard astronomical measurements.

The preliminary results of Sensitivity (i.e. G/Tsys in units of K / Jy / k) measurements are shown in fig. 12.

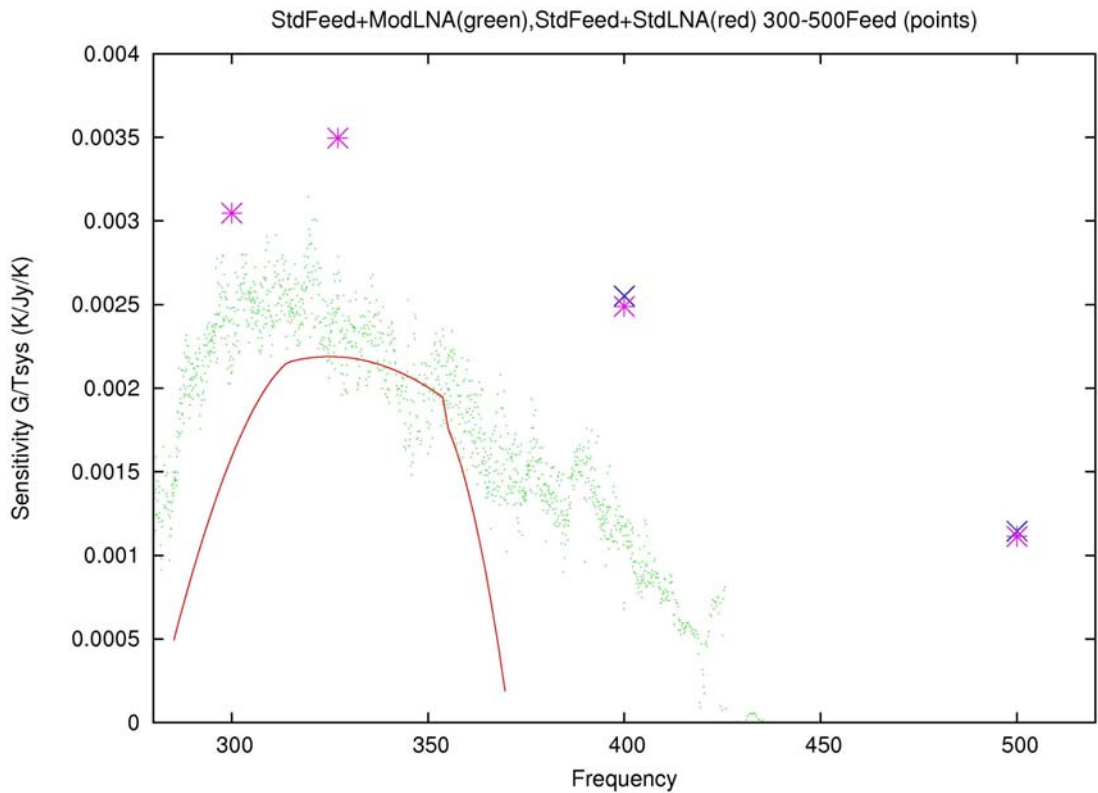

Courtesy : JNC

Fig.12 Sensitivity (G/Tsys)

Fig. 13 Broadband 300_500 MHz CYGA Source Deflection at C08 Antenna

CH1 Source ON

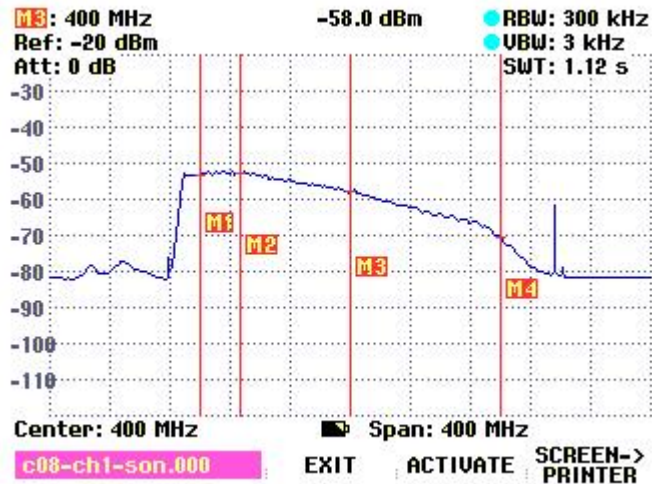

CH1 Source OFF

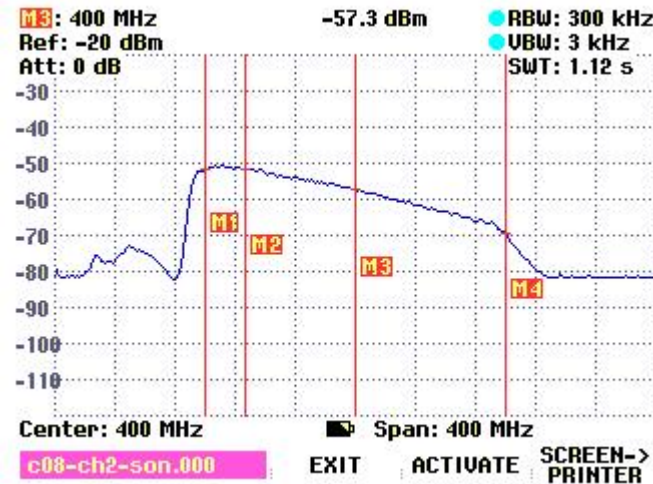

| Frequency (MHz) | S_ON (dBm) | S_OFF (dBm) | Deflection (dB) |
|-----------------|------------|-------------|-----------------|
| 300 | -53.4 | -66.2 | 12.8 |
| 327 | -52.7 | -65.8 | 13.1 |
| 400 | -58.2 | -69.4 | 11.2 |
| 500 | -70.4 | -77.9 | 7.5 |

CH2 Source ON

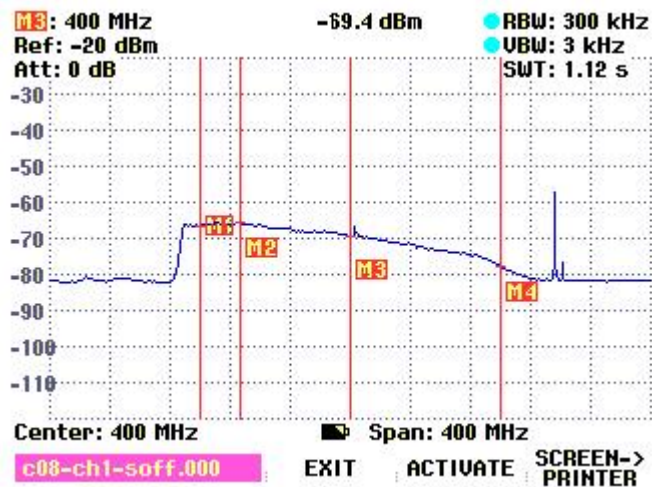

CH2 Source OFF

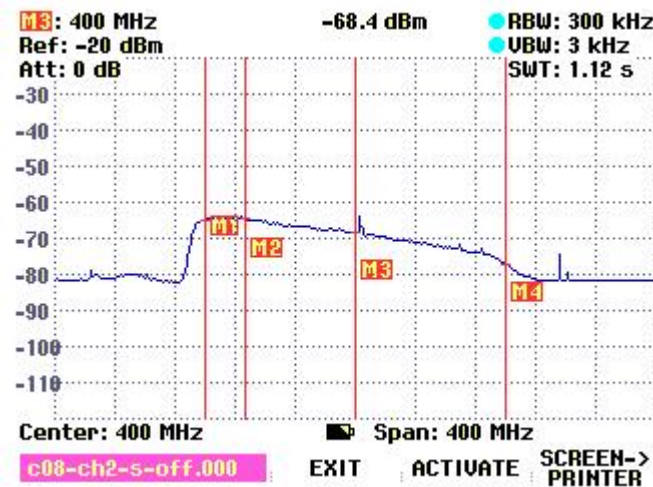

| Frequency (MHz) | S_ON (dBm) | S_OFF (dBm) | Deflection (dB) |
|-----------------|------------|-------------|-----------------|
| 300 | -51.8 | -64.6 | 12.8 |
| 327 | -51.3 | -64.4 | 13.1 |
| 400 | -57.4 | -68.5 | 11.1 |
| 500 | -69.6 | -77.0 | 7.4 |

7.References

1. A Praveen Kumar and M. Srinivas, *Signal Flow Analysis of the GMRT Receiver System*, GMRT
Internal Technical Report, October 1996.
2. Jayaram N. Chengalur, sep 2010, *Astronomical measurements of the performance of the modified broadband 327 MHz system*.
3. Bhalerao V. B, 2010, *Wide Bandpass Filter for 327 MHz Front End GMRT Receiver*.
4. www.sagelabs.com
5. HMC616LP3 datasheet <http://www.hittite.com/products/view.html/view/HMC616LP3>



HMC616LP3 / 616LP3E

GaAs SMT PHEMT LOW NOISE AMPLIFIER, 175 - 660 MHz

Typical Applications

The HMC616LP3(E) is ideal for:

- Cellular/3G and LTE/WiMAX/4G
- BTS & Infrastructure
- Repeaters and Femtocells
- Public Safety Radio
- DAB Receivers

Features

- Low Noise Figure: 0.5 dB
- High Gain: 24 dB
- High Output IP3: +37 dBm
- Single Supply: +3V to +5V
- 50 Ohm Matched Input/Output
- 16 Lead 3x3mm QFN Package: 9 mm²

Functional Diagram

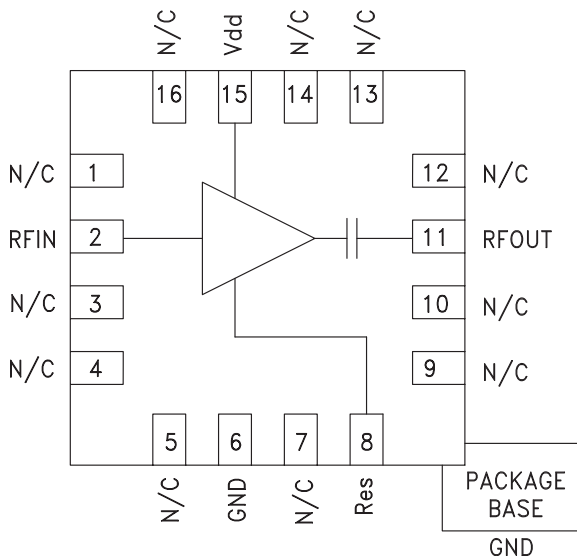

General Description

The HMC616LP3(E) is a GaAs PHEMT MMIC Low Noise Amplifier that is ideal for Cellular/3G and LTE/WiMAX/4G basestation front-end receivers operating between 175 and 660 MHz. The amplifier has been optimized to provide 0.5 dB noise figure, 24 dB gain and +37 dBm output IP3 from a single supply of +5V. Input and output return losses are excellent with minimal external matching and bias decoupling components. The HMC616LP3(E) shares the same package and pinout with the HMC617-LP3(E) and HMC618LP3(E) LNAs. The HMC616LP3(E) can be biased with +3V to +5V and features an externally adjustable supply current which allows the designer to tailor the linearity performance of the LNA for each application.

Electrical Specifications, $T_A = +25^\circ\text{C}$, $R_{bias} = 3.92k\text{ Ohms}^*$

| Parameter | Vdd = +3 Vdc | | | | | | Vdd = +5 Vdc | | | | | | Units |
|--|--------------|------|------|-----------|-------|------|--------------|------|------|-----------|-------|------|-------|
| | Min. | Typ. | Max. | Min. | Typ. | Max. | Min. | Typ. | Max. | Min. | Typ. | Max. | |
| Frequency Range | 175 - 230 | | | 230 - 660 | | | 175 - 230 | | | 230 - 660 | | | MHz |
| Gain | 20 | 22.5 | | 15 | 20 | | 21 | 24 | | 15 | 21 | | dB |
| Gain Variation Over Temperature | | | | | 0.002 | | | | | | 0.005 | | dB/°C |
| Noise Figure | | 0.5 | 0.8 | | 0.5 | 0.8 | | 0.5 | 0.8 | | 0.5 | 0.8 | dB |
| Input Return Loss | | 10 | | | 16 | | | 12 | | | 14 | | dB |
| Output Return Loss | | 9 | | | 10 | | | 9 | | | 10 | | dB |
| Output Power for 1 dB Compression (P1dB) | 8 | 11 | | 10 | 15 | | 11 | 15 | | 14 | 19 | | dBm |
| Saturated Output Power (Psat) | 8.5 | 13 | | 11 | 15.5 | | 12.5 | 17.5 | | 15.5 | 19.5 | | dBm |
| Output Third Order Intercept (IP3) | | 20 | | | 30 | | | 32 | | | 37 | | dBm |
| Supply Current (Idd) | | 30 | 45 | | 30 | 45 | | 90 | 115 | | 90 | 115 | mA |

* Rbias resistor sets current, see application circuit herein

Broadband Gain & Return Loss

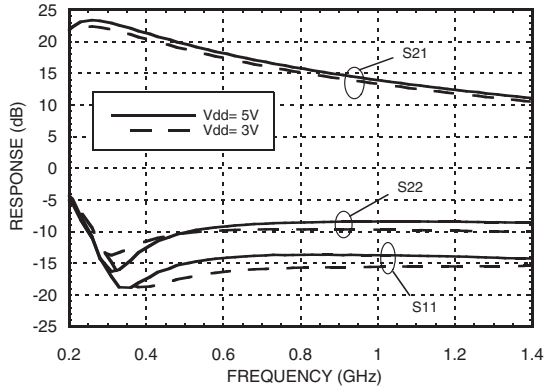

Gain vs. Temperature [1]

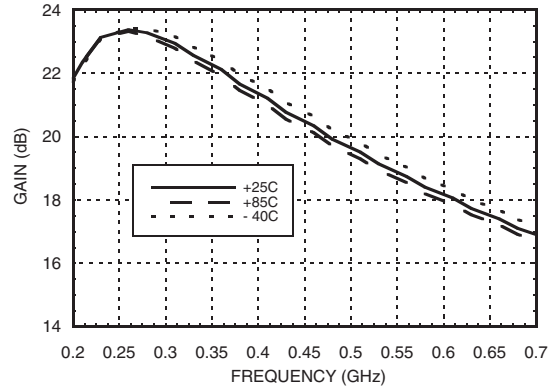

Gain vs. Temperature [2]

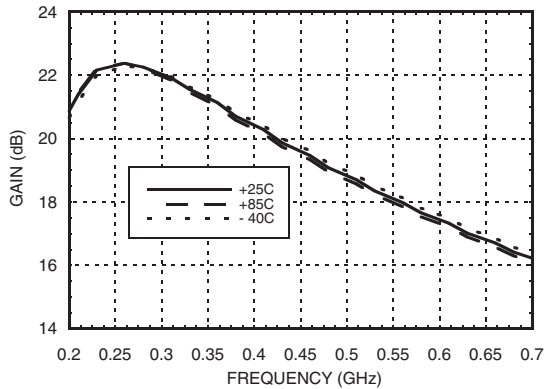

Input Return Loss vs. Temperature [1]

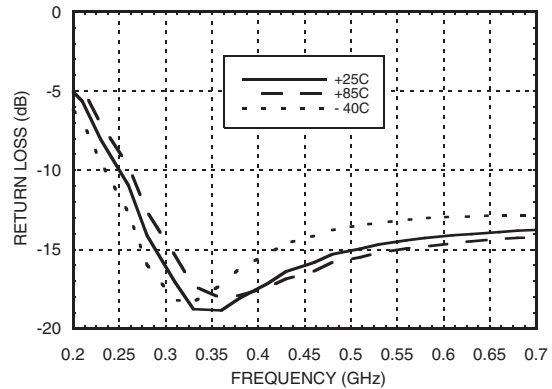

Output Return Loss vs. Temperature [1]

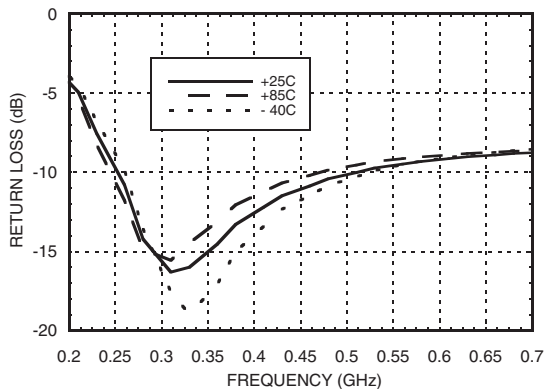

Reverse Isolation vs. Temperature [1]

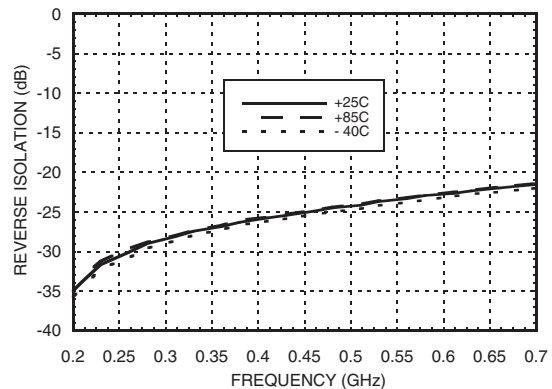

[1] Vdd = 5V [2] Vdd = 3V

Noise Figure vs. Temperature [1]

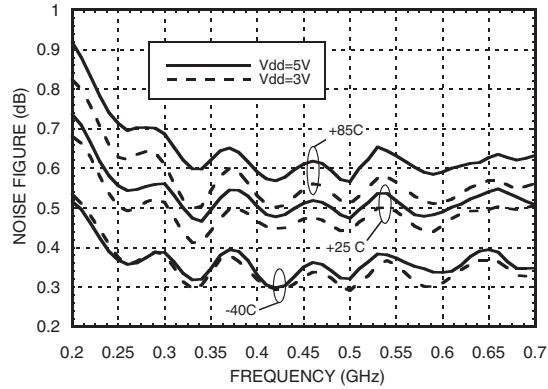

P1dB vs. Temperature

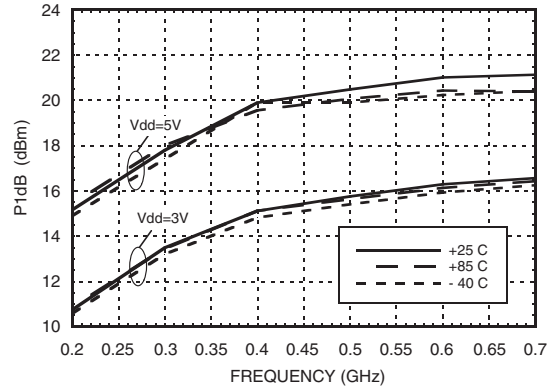

Psat vs. Temperature

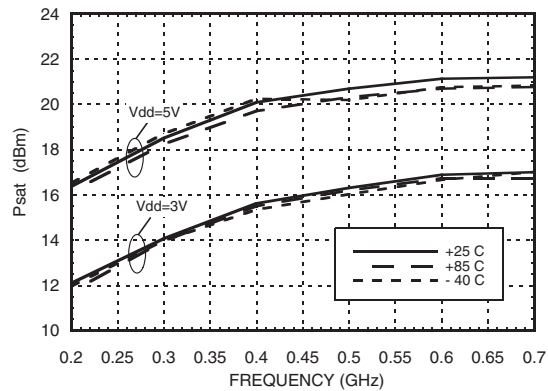

Output IP3 vs. Temperature

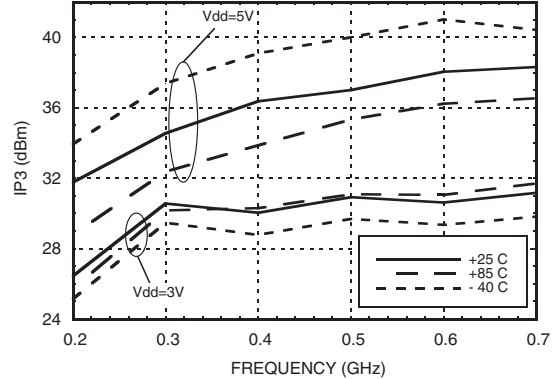

Output IP3 and I_{dd} vs. Supply Voltage @ 400 MHz

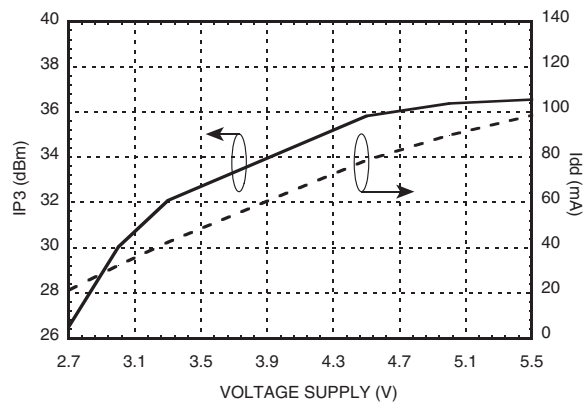

Output IP3 and I_{dd} vs. Supply Voltage @ 500 MHz

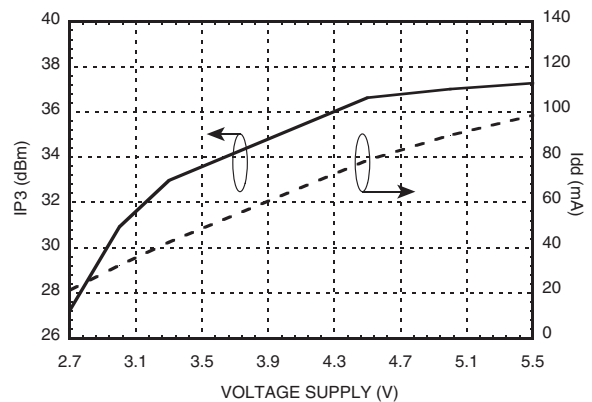

[1] Measurement reference plane shown on evaluation PCB drawing.



Power Compression @ 400 MHz [1]

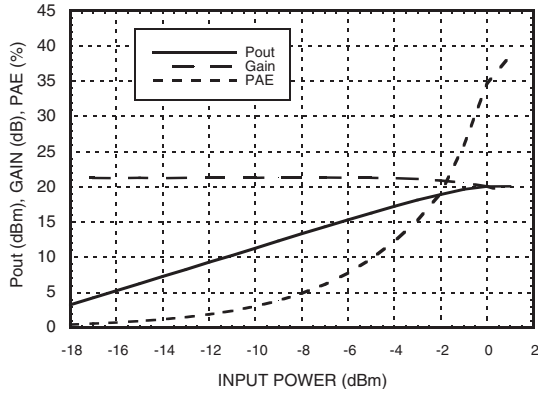

Power Compression @ 400 MHz [2]

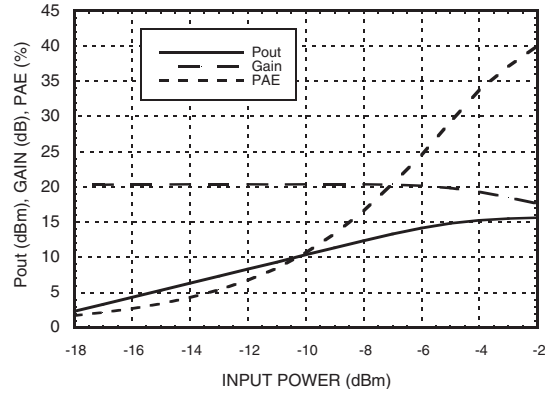

Power Compression @ 500 MHz [1]

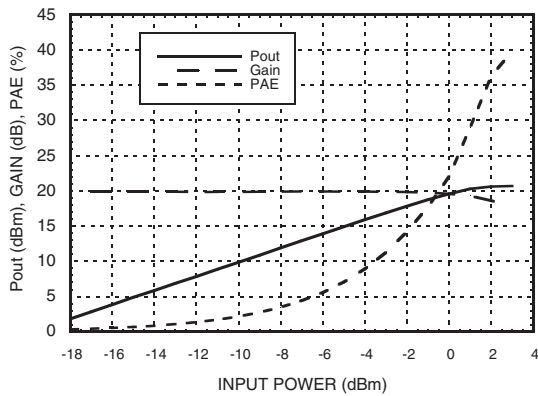

Power Compression @ 500 MHz [2]

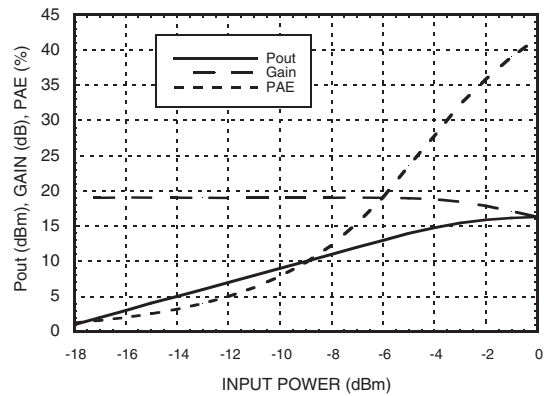

**Gain, Power & Noise Figure
vs. Supply Voltage @ 400 MHz**

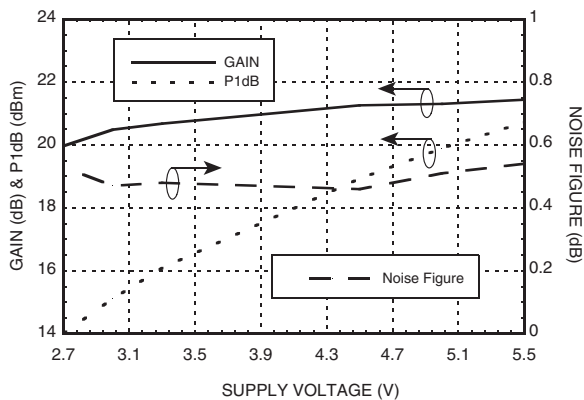

**Gain, Power & Noise Figure
vs. Supply Voltage @ 500 MHz**

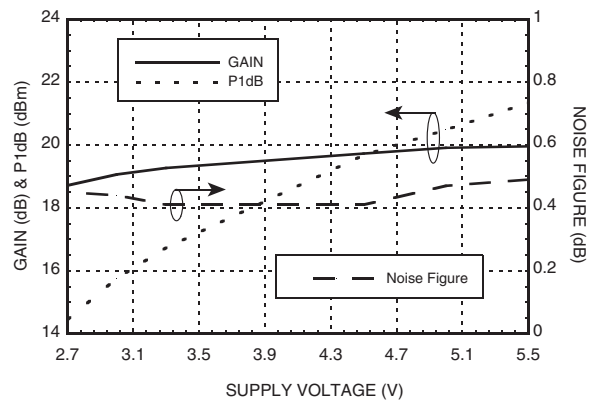

[1] Vdd = 5V [2] Vdd = 3V

Gain Low Frequency Tune [1]

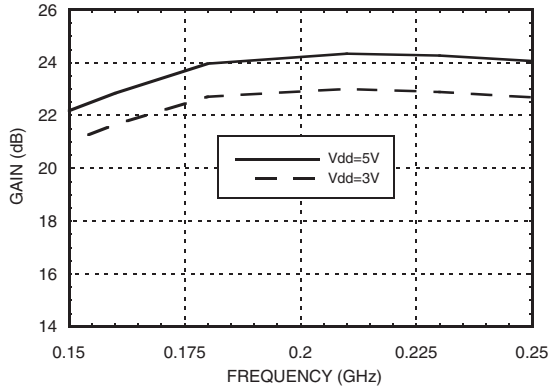

Input Return Loss Low Frequency Tune [1]

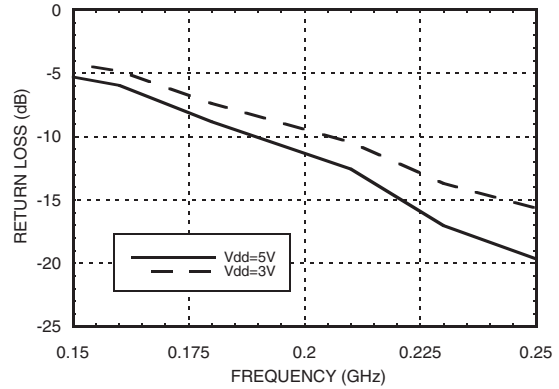

Output Return Loss Low Frequency Tune [1]

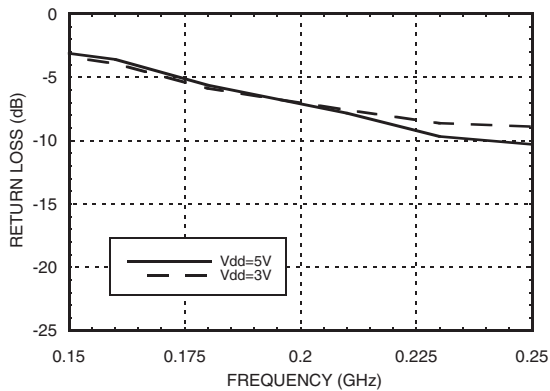

P1dB Low Frequency Tune [1]

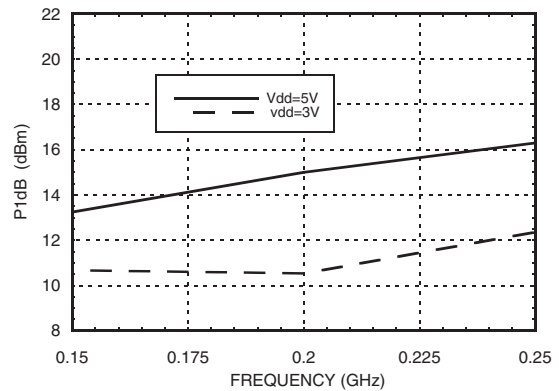

Output IP3 Low Frequency Tune [1]

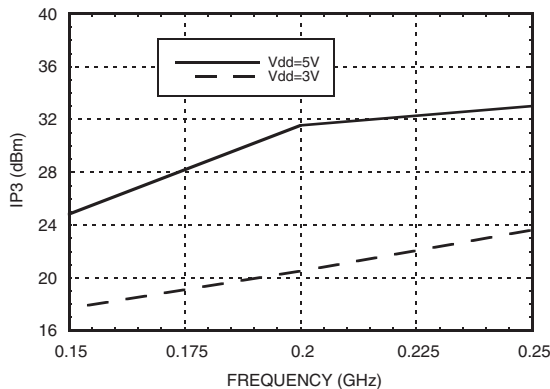

Noise Figure Low Frequency Tune [1] [2]

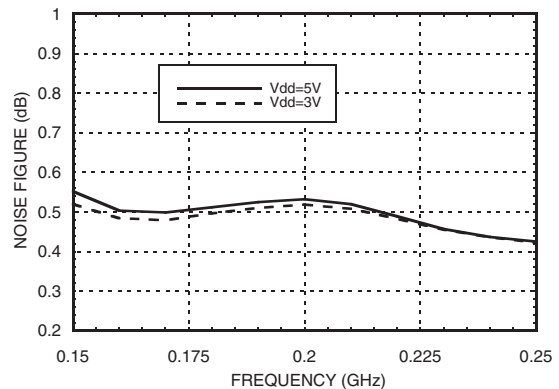

[1] Rbias = 2kΩ, L1 = 82 nH, L2 = 82 nH [2] Measurement reference plane shown on evaluation PCB drawing.

Output IP3 vs. Rbias @ 400 MHz

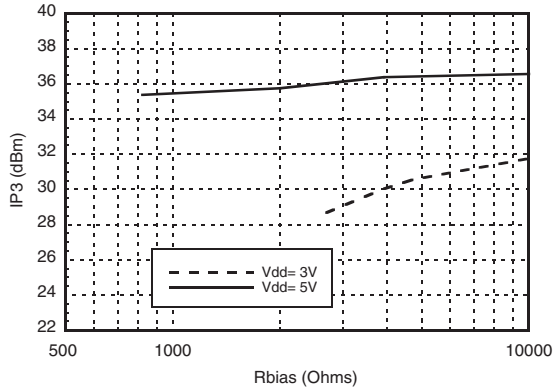

Gain, Noise Figure & Rbias @ 400 MHz

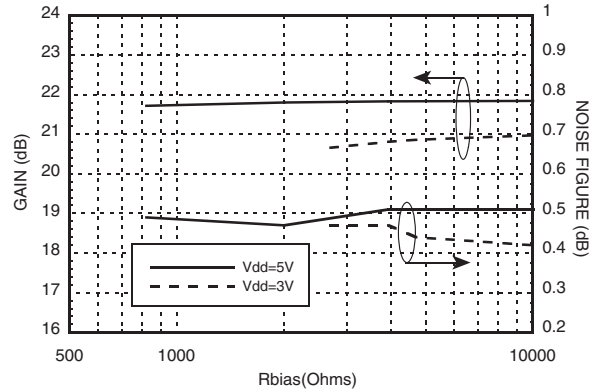

Output IP3 vs. Rbias @ 500 MHz

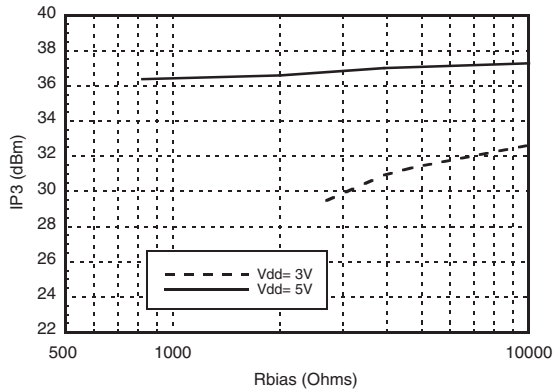

Gain, Noise Figure & Rbias @ 500 MHz

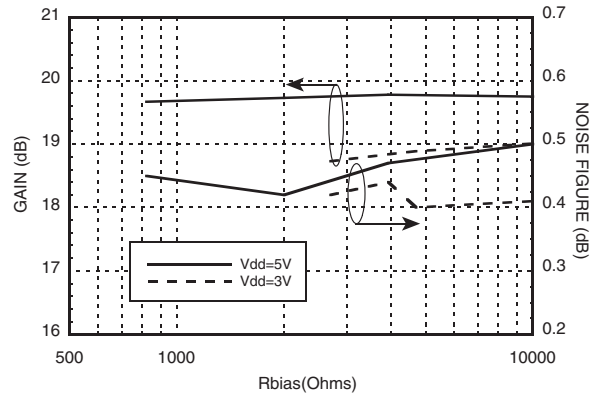

Absolute Bias Resistor
Range & Recommended Bias Resistor Values for I_{dd}

| V _{dd} (V) | R _{bias} (Ω) | | | I _{dd} (mA) |
|---------------------|-----------------------|--------------|-------------|----------------------|
| | Min | Max | Recommended | |
| 3V | 1K [1] | Open Circuit | 2.7k | 27 |
| | | | 3.92k | 31 |
| | | | 4.7k | 33 |
| | | | 10k | 39 |
| 5V | 0 | Open Circuit | 820 | 73 |
| | | | 2k | 84 |
| | | | 3.92k | 91 |
| | | | 10k | 95 |

[1] With V_{dd} = 3V, R_{bias} < 1K Ohm is not recommended and may result in the LNA becoming conditionally stable.

Absolute Maximum Ratings

| | |
|---|----------------|
| Drain Bias Voltage (V _{dd}) | +6 Vdc |
| RF Input Power (RFIN) (V _{dd} = +5 Vdc) | +10 dBm |
| Channel Temperature | 150 °C |
| Continuous P _{diss} (T = 85 °C) (derate 8.93 mW/°C above 85 °C) | 0.58 W |
| Thermal Resistance (channel to ground paddle) | 112 °C/W |
| Storage Temperature | -65 to +150 °C |
| Operating Temperature | -40 to +85 °C |

Typical Supply
Current vs. V_{dd} (R_{bias} = 3.92kΩ)

| V _{dd} (Vdc) | I _{dd} (mA) |
|-----------------------|----------------------|
| 2.7 | 20 |
| 3.0 | 30 |
| 3.3 | 40 |
| 4.5 | 80 |
| 5.0 | 90 |
| 5.5 | 100 |

Note: Amplifier will operate over full voltage range shown above.



**ELECTROSTATIC SENSITIVE DEVICE
OBSERVE HANDLING PRECAUTIONS**

Outline Drawing

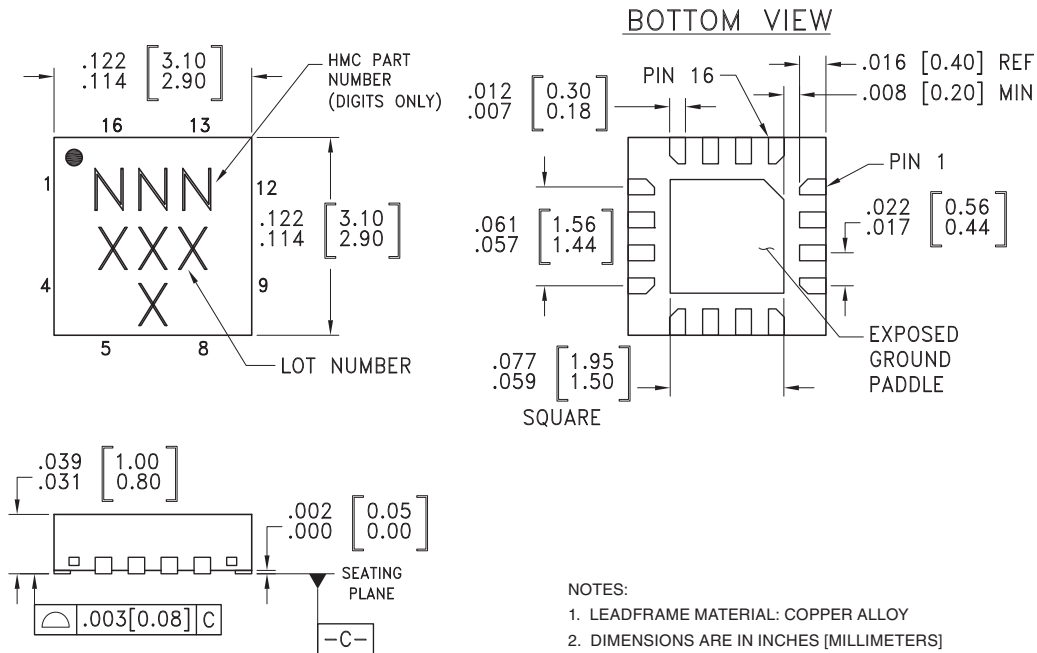

NOTES:

1. LEADFRAME MATERIAL: COPPER ALLOY
2. DIMENSIONS ARE IN INCHES [MILLIMETERS]
3. LEAD SPACING TOLERANCE IS NON-CUMULATIVE
4. PAD BURR LENGTH SHALL BE 0.15mm MAXIMUM. PAD BURR HEIGHT SHALL BE 0.05mm MAXIMUM.
5. PACKAGE WARP SHALL NOT EXCEED 0.05mm.
6. ALL GROUND LEADS AND GROUND PADDLE MUST BE SOLDERED TO PCB RF GROUND.
7. REFER TO HITTITE APPLICATION NOTE FOR SUGGESTED LAND PATTERN.

Package Information

| Part Number | Package Body Material | Lead Finish | MSL Rating | Package Marking ^[3] |
|-------------|--|---------------|---------------------|--------------------------------|
| HMC616LP3 | Low Stress Injection Molded Plastic | Sn/Pb Solder | MSL1 ^[1] | 616 XXXX |
| HMC616LP3E | RoHS-compliant Low Stress Injection Molded Plastic | 100% matte Sn | MSL1 ^[2] | 616 XXXX |

[1] Max peak reflow temperature of 235 °C

[2] Max peak reflow temperature of 260 °C

[3] 4-Digit lot number XXXX

Pin Descriptions

| Pin Number | Function | Description | Interface Schematic |
|---------------------------------|----------|--|---------------------|
| 1, 3 - 5, 7, 9, 10, 12 - 14, 16 | N/C | No connection required. These pins may be connected to RF/DC ground without affecting performance. | |
| 2 | RFIN | This pin is DC coupled. DC blocking capacitor required. See application circuit. | RFIN —○— |
| 6 | GND | This pin and ground paddle must be connected to RF/DC ground. | ○ GND ⏏ |
| 11 | RFOUT | This pin is matched to 50 Ohms. | —○ RFOUT ⏏ |
| 8 | RES | This pin is used to set the DC current of the amplifier by selection of external bias resistor. See application circuit. | —○ RES ⏏ |
| 15 | Vdd | Power Supply Voltage. Choke inductor and bypass capacitors are required. See application circuit. | Vdd ⏏ |

Application Circuit

Components for Selected Frequencies

| Tuned Frequency | 175 - 230 MHz | 230 - 660 MHz |
|-----------------|---------------|---------------|
| Rbias | 2.0k Ohms | 3.92k Ohms |
| L1 | 82 nH | 18 nH |
| L2 | 82 nH | 51 nH |

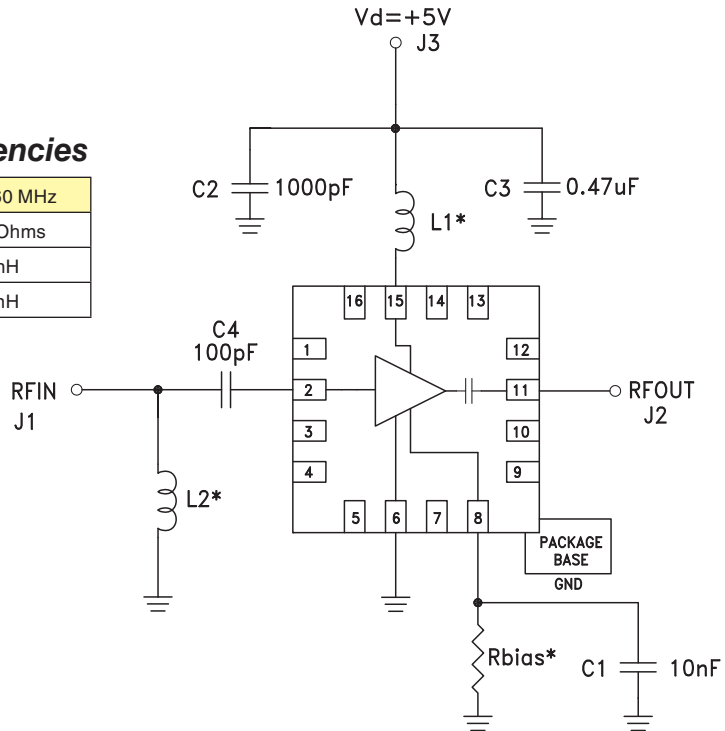

REFER TO TABLE FOR X VALUES

Evaluation PCB

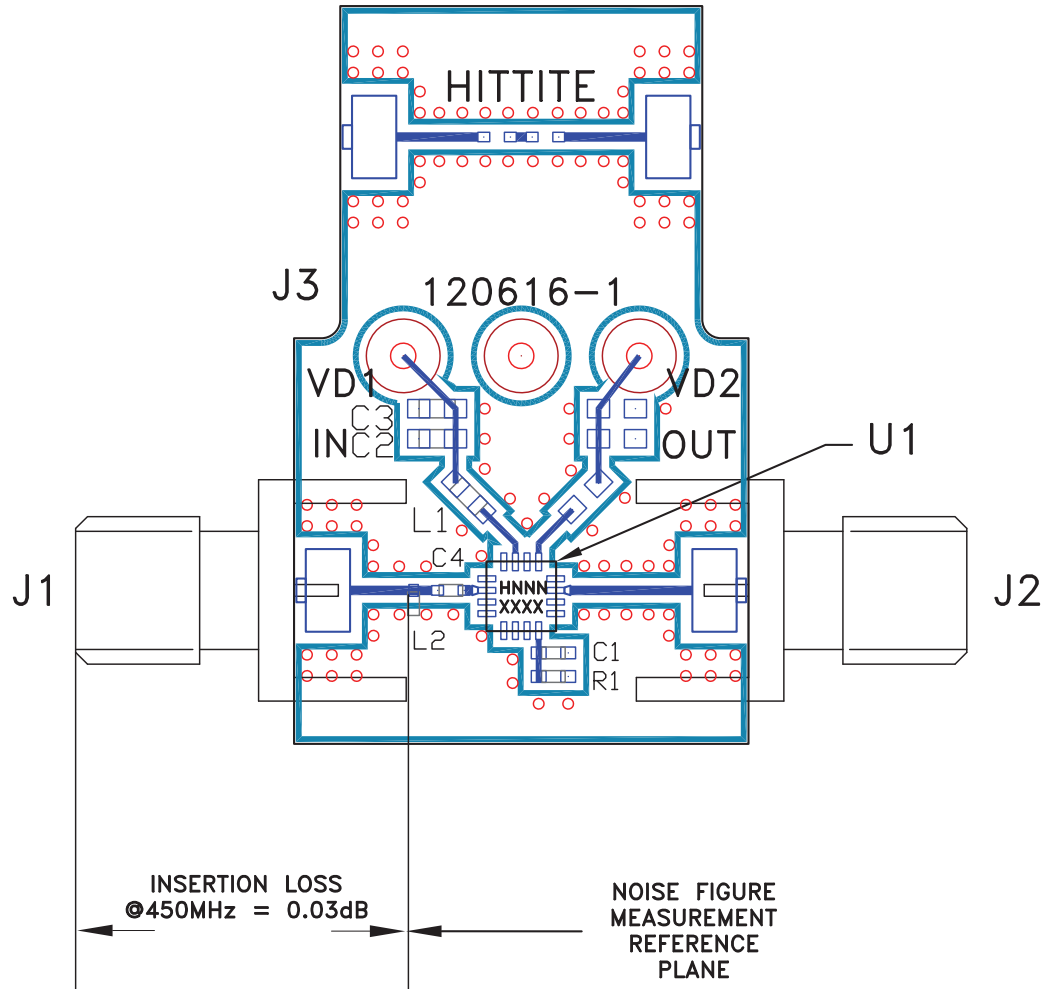

List of Material for Evaluation PCB 120728 [1]

| Item | Description |
|------------|------------------------------|
| J1, J2 | PCB Mount SMA RF Connector |
| J3, J4 | DC Pin |
| C1 | 10nF Capacitor, 0402 Pkg. |
| C2 | 1000 pF Capacitor, 0603 Pkg. |
| C3 | 0.47µF Capacitor, 0603 Pkg. |
| C4 | 100 pF Capacitor, 0402 Pkg. |
| L1 | 18 nH Inductor, 0603 Pkg. |
| L2 | 51 nH Inductor, 0402 Pkg. |
| R1 (Rbias) | 3.92 kΩ Resistor, 0402 Pkg. |
| U1 | HMC616LP3(E) Amplifier |
| PCB [2] | 120616 Evaluation PCB |

[1] Reference this number when ordering complete evaluation PCB

[2] Circuit Board Material: Rogers 4350.

The circuit board used in this application should use RF circuit design techniques. Signal lines should have 50 ohm impedance while the package ground leads and exposed paddle should be connected directly to the ground plane similar to that shown. A sufficient number of via holes should be used to connect the top and bottom ground planes. The evaluation board should be mounted to an appropriate heat sink. The evaluation circuit board shown is available from Hittite upon request.

PRODUCT SPECIFICATION

QUADRATURE HYBRID HIGH POWER, OCTAVE BAND, 3 dB



FEATURES

- TYPE "N" Connectors
- Average Power Rating 1000 Watts, Normalized at 1 GHz
- 1 dB Maximum Unbalance
- Meet MIL-E-5400 Class 3 or Equivalent
- Screenable to MIL-P-23971 or Equivalent

TEMLINE™ SERIES

SPECIFICATIONS

| Frequency Range (MHz) | Isolation min (dB) | VSWR max | Insertion Loss, max ¹ (dB) | Model Number |
|-----------------------|--------------------|----------|---------------------------------------|--------------|
| 125-150 | 23 | 1.20 | 0.1 | 749 |
| 250-500 | 20 | 1.20 | 0.1 | 750 |
| 500-1000 | 20 | 1.25 | 0.1 | 751 |
| 1000-2000 | 20 | 1.25 | 0.1 | 752 |
| 2000-4000 | 20 | 1.25 | 0.1 | 753 |

NOTES:

1. Maximum loss is the actual dissipative loss and reflective loss due to VSWR. It does not include coupling loss.
2. Unbalance is measured as the difference between the coupled and mainline output ports from the mean coupling at each frequency.

OUTLINE DRAWING

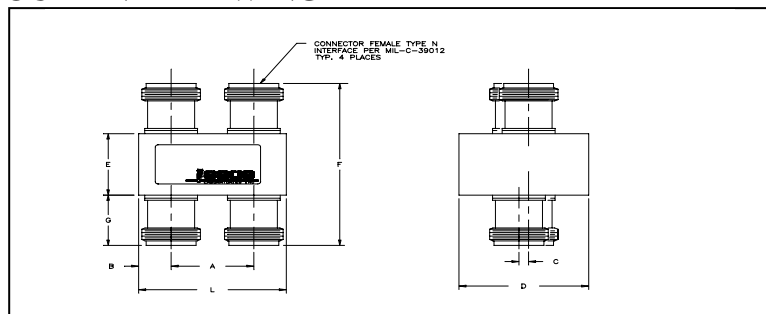

NOTES:

- B dimension for all models is .34" (0,86 cm)
 C dimension for all models is .10" (0,26 cm)
 D dimension for all models is 1.38 (3,51 cm)
 E dimension for all models is .88" (2,24 cm)
 F dimension for all models is 2.31" (5,87 cm)
 F dimension for all models is 2.31" (5,87 cm)
 G dimension for all models is .72" (1,83 cm)

| Model Number | A" | Dimensions (See Drawing) | | L (cm) | Weights | |
|--------------|-------|--------------------------|-------|---------|---------|-------|
| | | A (cm) | L" | | Ounces | Grams |
| 749 | 11.00 | (27,94) | 11.69 | (29,69) | 19 | 538 |
| 750 | 5.63 | (14,30) | 6.31 | (16,03) | 13 | 368 |
| 751 | 2.78 | (7,06) | 3.47 | (8,81) | 7 | 198 |
| 752 | 1.41 | (3,58) | 2.09 | (5,31) | 5 | 142 |
| 753 | .81 | (2,07) | 1.50 | (3,81) | 4 | 113 |

NOTES:

1. Sage Laboratories Inc. "Standard Warranty and Order Terms and Conditions" apply to all orders.
2. All specifications subject to change without notice.
3. Check "Ordering and Availability Listing" for delivery and ordering information.
4. Contact our local Manufacturers Representative for pricing.

Specification Revision - 100809

SAGE®

L A B O R A T O R I E S

Sage Laboratories, Inc. • 8 Executive Drive • Hudson, NH 03051 • Tel: 603-459-1600 • Fax: 603.459.1605

www.sagelabs.com